



Ex.: 5421 ACME\_CHG Configuration

COLOUR	BLACK/BLACK	BLUE/BLACK
		
	<b>B</b>	<b>C</b>







Order exemple: 5421 ACME\_CHG

Coupling ACME \_\_\_\_\_

Colour "Blue/Black" \_\_\_\_\_

H Lever (hook and magnet) \_\_\_\_\_

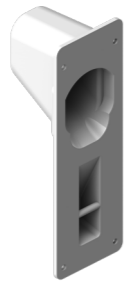
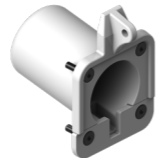
Gas swivel \_\_\_\_\_

LEVER	HOOKING	JOINT	STANDARD	FRENCH SUPPORT
				
Compatible with	Compatible with	Compatible with	Compatible with	
				
	<b>H</b>	<b>E</b>	<b>S</b>	<b>F</b>

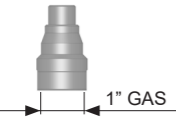
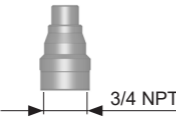
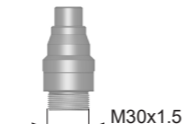
SWIVEL	GAS	NPT	M30x1.5
			
	<b>G</b>	<b>N</b>	<b>M</b>

Data sheet	
Maximum operating pressure	25 Bar
Static Test	40 Bar
Dynamic test	25 Bar
Maximum flow rate	40 l/min a 8 Bar
Release of gas when disconnected	1,35 cm <sup>3</sup>
Operating temperature	-30°C - +65°C
Weight	1,20 Kg
Type of coupling	Acme EN 12806
Swivel connexion	Acme Hook
Swivel connexion	1"GAS-3/4NPT-M30x1,5
Sleeve made of anti-spark material	
Antistatic body and plastic materials	

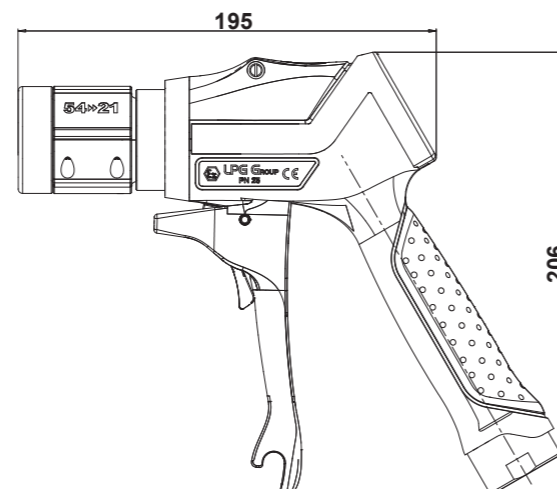

# 5421



*Avanti veloce!*



EN 

## 5421 ACME



LPG GROUP SRL Via Rinascita, 38, Ozzano dell'Emilia (BO) Italy  
T. +39.051.652 2059 \_ www.lpggroup.eu

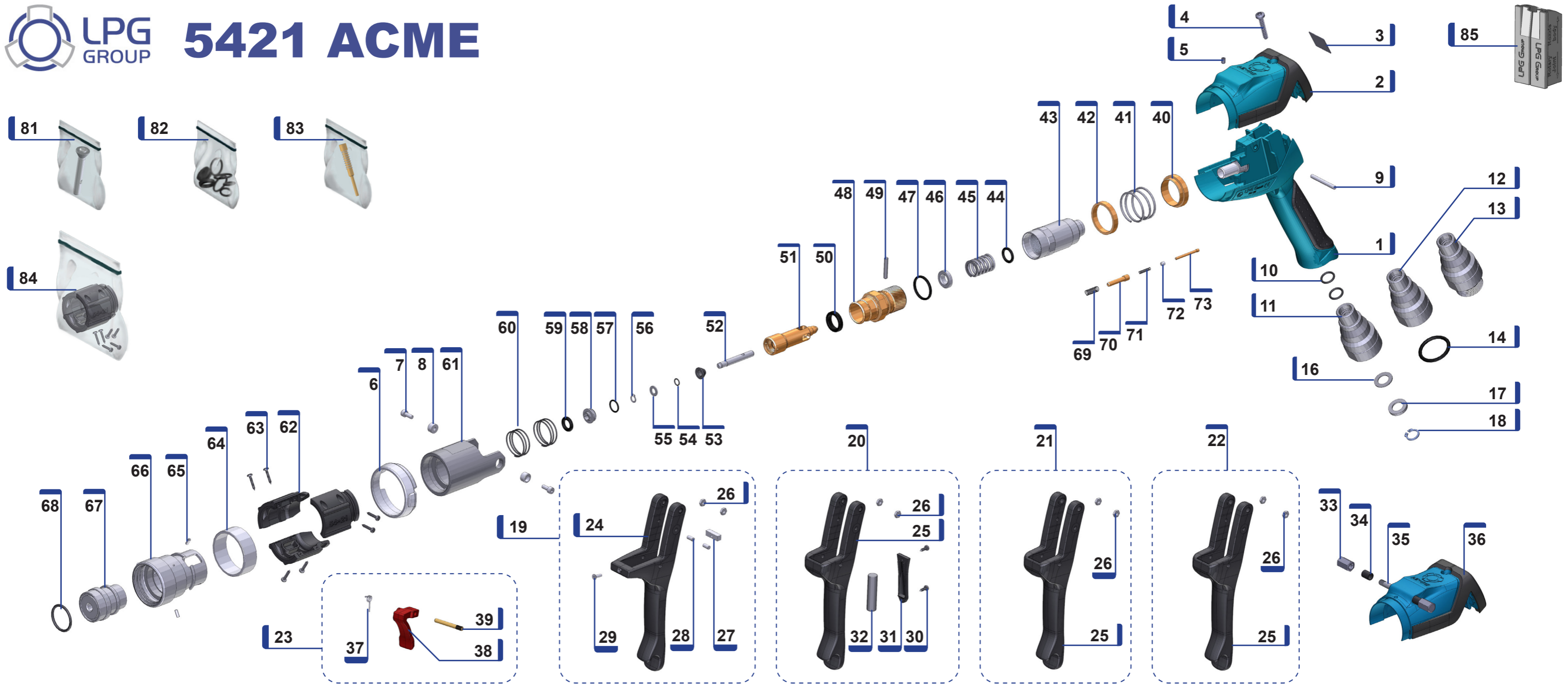

N.	Description	Code	Qt.	Notes
1	NOZZLE BODY C	5421_80	1	C - Blue/Black
	NOZZLE BODY B	5421_81		B - Black/Black
2	NOZZLE COVER C	5421_85	1	C - Blue/Black
	NOZZLE COVER B	5421_86		B - Black/Black
3	LPG STICKER	LPG 0111	1	
4	SCREW	5421_315	1	
5	SCREW	5421_318	1	
6	CLOSING RING	5421_31	1	
7	SCREW	5421_317	2	
8	FULCRUM BUSH	5421_71	2	
9	LEVER FULCRUM	5421_67	1	
10	O-RING 0120-20	5421_361	2	
11	FERRULE 3/4 NPT	5421_38	1	
12	FERRULE 1" GAS	5421_37		
13	FERRULE M30X1,5	5421_35		
14	O-RING 4112	LPG 0204	1	for gas swivel
16	THRUST SLEWING RING	5421_33	1	
17	WASHER	5421_39	1	
18	SEEGER D12	5421_360	1	
19	COMPLETE H LEVER	5421_12		hooking

N.	Description	Code	Qt.	Notes
20	COMPLETE E LEVER	5421_15		joint
21	COMPLETE S LEVER	5421_21		standard
22	COMPLETE F LEVER	5421_22		french support
23	TRIGGER KIT	5421_347		
24	H LEVER	5421_64	1	
25	S LEVER	5421_65	1	
26	NUT ISO 4035 M4-8	5421_312	2	
27	MATCHING HOOK	5421_69	1	for H lever
28	MAGNET	5421_301	2	for H lever
29	SCREW TSEI M3X10	5421_313	1	for H lever
30	SCREW	5421_314	2	for E lever
31	MAGNET COVER	5421_70	1	for E lever
32	MAGNET D10	5421_302	1	for E lever
33	HOOING DICE FR	LPG 0210	2	for FR. Support
34	SPACER	5421_74	2	for FR. Support
35	SUPPORT PIVOT FR	LPG 0211	1	for FR. Support
36	NOZZLE COVER F C	5421_95	1	for FR. Support
	NOZZLE COVER F B	5421_96		C - Blue/Black B - Black/Black
37	TRIGGER SPRING	5421_63	1	
38	TRIGGER	5421_62	1	

N.	Description	Code	Qt.	Notes
39	TRIGGER PIN	5421_68	1	
40	SHAVING RING	5421_121	1	
41	RETURN SPRING	5421_123	1	
42	SHAVING RING	5421_122	1	
43	E1 VALVE BODY	5421_115	1	
44	O-RING 115	5421_331	1	
45	VALVE SPRING	5421_125	1	
46	WASHER	5421_124	1	
47	O-RING 128	5421_333	1	
48	HEAD VALVE KB	5421_215	1	
49	HEAD PIN	5421_305	1	
50	LIP GASKET DI062	LPG 0207	1	
51	VALVE PLUNGER	5421_216	1	
52	VALVE PIN 137	5421_137	1	
53	HEAD VALVE PIN	5421_114	1	
54	O-RING 0060-10	5421_365	1	
55	RETURN VALVE PIN	5421_113	1	
56	SEEGER DIN 471-6	5421_364	1	
57	ORM 0110-15	5421_330	1	
58	HEAD GASKET	5421_226	1	

N.	Description	Code	Qt.	Notes
59	O-RING 4036	5421_338	1	
60	SPRING	5421_220	2	
61	SLEEVE A/S	5421_179	1	
62	EXTERNAL FERRULE A/S	5421_181	3	
63	SCREW	5421_320	6	
64	EXTERNAL RING ACME	5421_187	1	
65	GRAIN	5421_322	3	
66	HOOING BUSH ACME	5421_180	1	
67	VALVE BUSH ACME	5421_188	1	
68	O-RING 3100	5421_341	1	
69	SECURITY SPRING	5421_185	1	
70	SECURITY BODY PIN	5421_177	1	
71	SECURITY MOVABLE PIN	5421_176	1	
72	INTERNAL SECURITY SPRING	5421_178	1	
73	GRAIN	5421_323	1	
81	VALVE PIN KIT	5421_376		
82	ACME GASKET KIT	5421_343		
83	SECURITY BLOCK KIT A/S	5421_184		
84	SLEEVE KIT A/S	5421_382		
85	JAWS KIT	5421_371		